

HIGH TEMP HEAT PUMP WATER HEATER

Installation & Instruction Manual

CONTENTS

I .To our customers(before installation)-----1

II .Product Introducing-----2

III .Work principle-----3

IV .Performance Data-----4

V .Dimension-----5

VI .Operation introductions-----6

VII .Appendix-----11

VIII .Wire Circuit Diagram-----12

IX .Installation instructions-----13

X .Maintenance-----17

Dear Sir:

In order to use this machine safely, please read this INSTRUCTION MANUAL carefully before using and installation. Heat pump water heater is a professional machine, it may cause damage or hazard when wrong installed, it should be installed by a competent person in accordance with the relevant standards for the country of use.

WARNING:***ELECTRICAL POWER MUST BE SWITCHED OFF
BEFORE STARTING ANY WORK ON JUNCTION BOXES***

- 1. Before installing the heat pump, please ensure that the electrical supply corresponds to the specification indicated on the unit's rating label before proceeding with the connection in accordance with the wiring diagram supplied. Please check carefully on the rating label and the wiring diagrams that pasted on each heat pump unit.**
- 2. The unit must be EARTHED to avoid any risks caused by insulation defects. It is forbidden to start any work on the electrical components without switching off the electrical supply to the unit. Electric leakage switch protection device MUST be installed.**
- 3. It is forbidden to start any work on the electrical components if water or high humidity is present on the installation site.**
- 4. When the unit is being connected, ensure that no impurities are introduced into the pipe work and the water circuits.**
- 5. All maintenance or repairmen of the heat pump must be performed by competent technicians.**
- 6. It could be hurtful when generated hot water reaches 52 °C, please mix with cold water before using.**
- 7. To prevent any damage to the fan or any accidents, it is forbidden to put your fingers or any other objects into the air outlet. Kids or children should be kept away from the heat pump.**
- 8. This appliance is not intended for use by persons (including children) with reduced physical, sensory or mental capabilities, or lack of experience and knowledge, unless they have been given supervision or instruction concerning use of the appliance by a person responsible for their safety.**
- 9. Children should be supervised to ensure that they do not play with the appliance.**

Product Introducing

⊙ **Safe and Reliable**

Unlike traditional electric water heater, heat pump water heater do not directly generate heat by electricity, it use less electricity to move heat from one place to another, electric circuit is separated from water circuit, which is also not easy for electric shock, inflammable, explosion and poisoning! Safer and more reliable!

⊙ **Highly efficient & Energy saving**

Heat pump water heater absorb plenty of heat from free ambient air, and can supply same hot water volume as electric heater. Electricity consumption is only 1/4 compared to electric heater, very energy saving!

⊙ **Environmental Friendly**

Heat pump not only use less electricity to get heat from ambient air, but are also able to combine using with solar equipment, will not cause pollution and no poison gas exhausting.

⊙ **All Round The Year Hot Water**

Heat pump water heaters are not affected by seasonal climate, provide hot water all year round even in cloudy or rainy days!

⊙ **Durable and long-lasting time**

Heat pump spare parts such as compressor and 4-way-valve are made by famous brand manufacturer, and casing panel is corrosion resistance, very durable and long-lasting time.

⊙ **Convenient Installation**

Installation site for heat pump can be the roof, the garage, the kitchen, the storing room, the basement and so on, very convenient on installation.

⊙ **Wide Application**

Heat pump water heaters are applicable for family, factory, school, hotel, hospital, and laundry, etc. Wide application for different using request.

Work principle

The low temperature and low pressure refrigerant gas come from the evaporate to the compressor, After the compressor compress it , the refrigerant gas became high temperature and high pressure. Then the gas come into the water condensation into liquid, emit a lot of condensation heat, condensing heat absorbed by water, making the water temperature increased, and then the liquid refrigerant come through the expansion valve, with a fan , the evaporate heat in the air, after all evaporation , the low pressure compressor refrigerant gas inhalation in the compressor, after working through the compressor, a high temperature and high pressure of the refrigerant gas from the compressor to exhaust emissions, such reciprocating cycle.

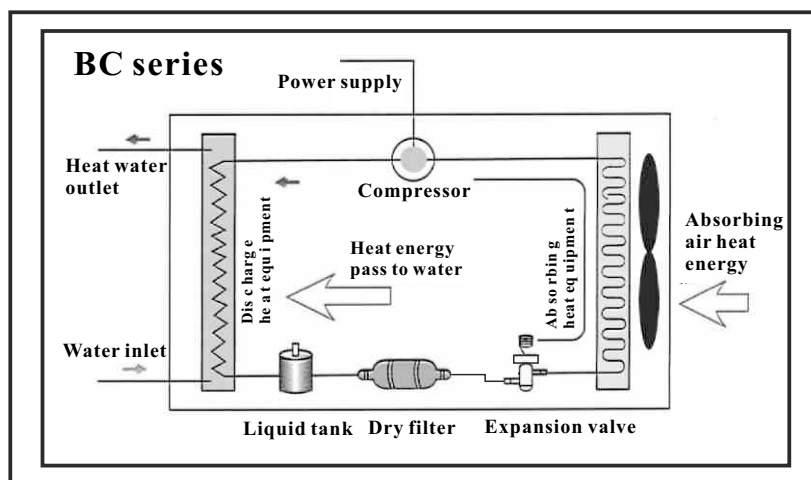
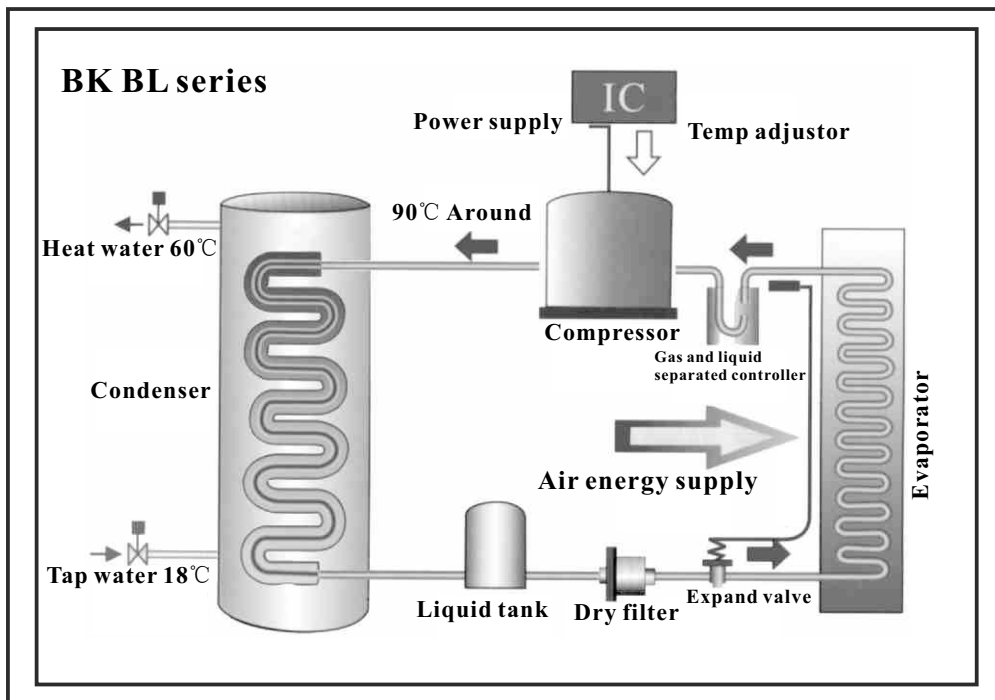

Performance Data

Model	SWBH-13.0H-A-S	
Rated heating capacity(w)	13000W	
Power supply(V/Ph/Hz)	380V/3PH/50HZ	
Input power(kw)	2.9KW	
Running current(A)	5.6Ax3	
Circulating unit hot water generated(L/h)	heat up water: 40℃ → 80℃	257L/h
	heat up water: 60℃ → 80℃	460L/h
Thermostat factory setting(℃)	60℃	
Thermostat maximum setting(℃)	80℃	
Water connections(mm)	1	
Compressor quantity	1	
Fan motor quantity	1	
Fan motor input(w)	350	
Fan speed(RPM)	850	
Noise(dB(A))	63	
Net dimension(mm)	810*860*975	
Net weight(kg)	148	

Measuring conditions: dry bulb 20℃, wet bulb 15℃, water inlet 40℃, water outlet 45℃.

● The dimension for high temp heat pump water heater

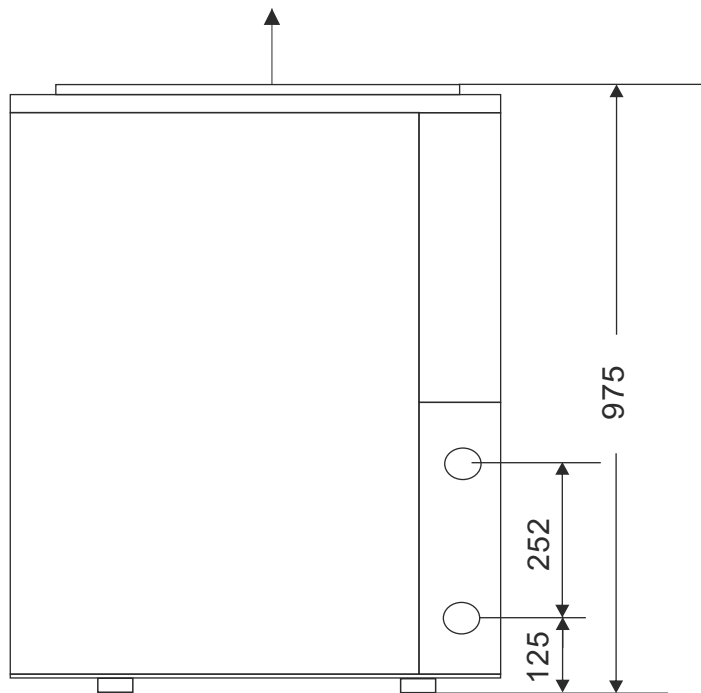
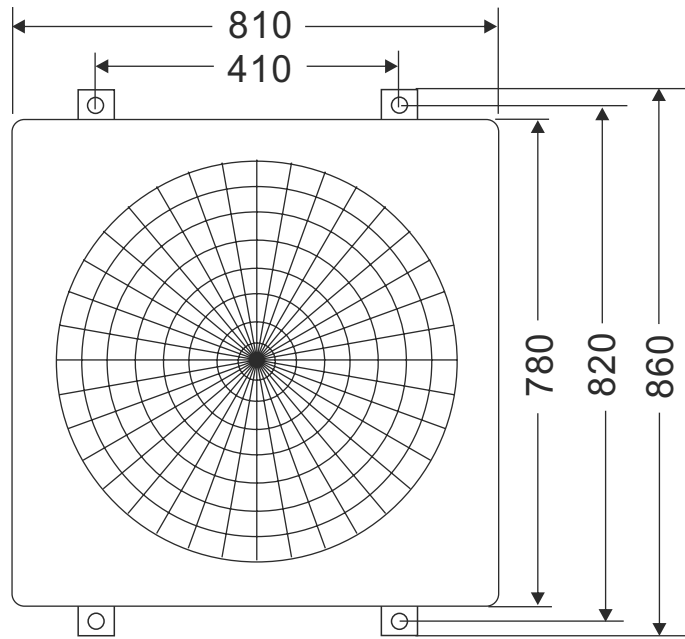

Controller introduction

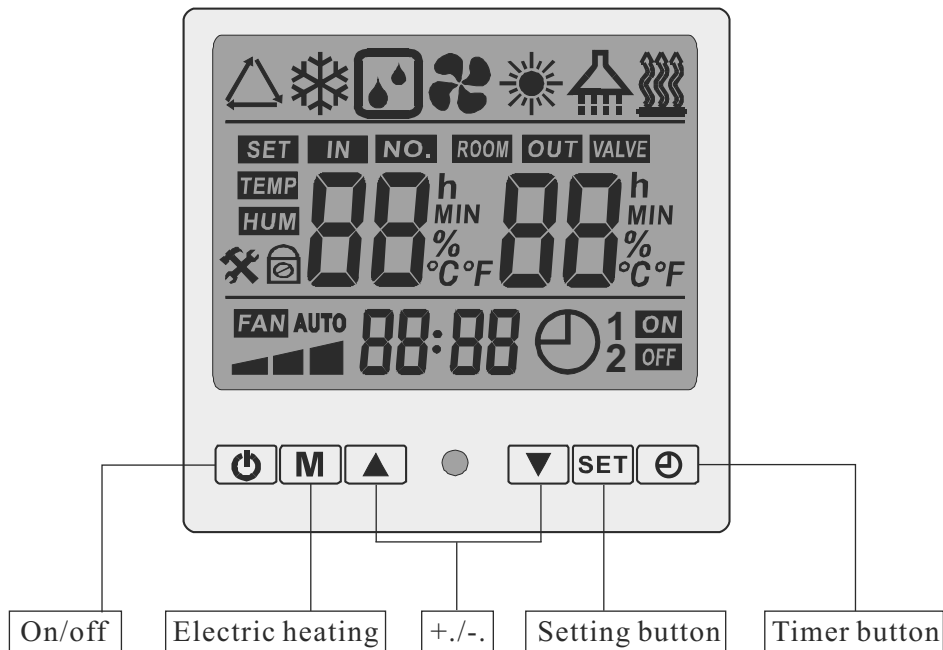

Note: Some button may not be suitable for all model, As the model update frequently, some operation may not be the same as instructed in this manual. Please refer to the controller operation instruction.

Operation

1.STANDBY mode(see Fig.1)

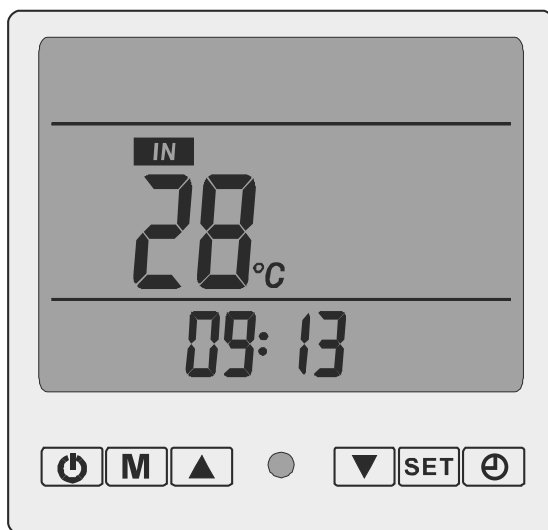



Fig.1

2.  Button is to switch between operation mode and standby mode, operation mode as shown in Fig.2. The temperature showed under "IN" is the temperature of hot water in water tank.

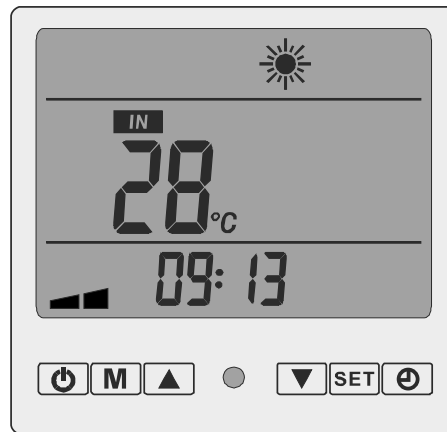





Fig.2

3.  Button is to switch to electric heating mode, see Fig.3:

 Button is applicable to electric heating function.

If electric heating function on, then  &  will appear at the same time.

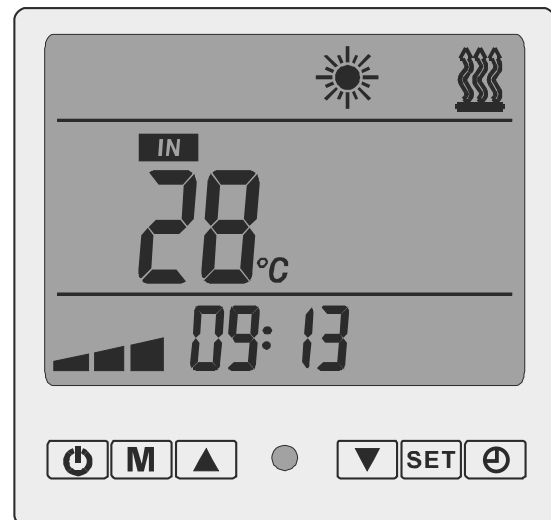





Fig.3

Note: The  shows on screen means the operating mode for water pump, compressor and electric heating, the  means the water pump is running, the  means the compressor is running, the  means the electric function is on. If their symbol disappear, means they are not running.

Attention: For more models, compressor  &  electric heating function don't run at the same time.

4. Clock setting:

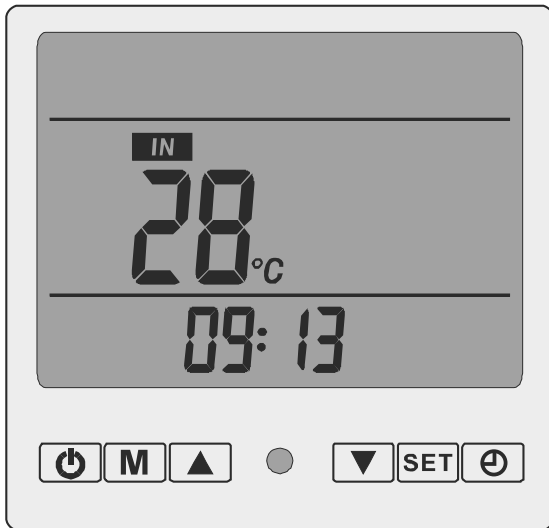

Fig.4

Under standby mode or operation mode, press **SET** to enter clock setting, see Fig.4.

09 Blink, press **▲** or **▼** to adjust hour; press **SET** again, **13** blink, press **▲** or **▼** to set minute. After setting, press **SET** again to confirm your settings.

The screen will show your set clock.

5. Timer setting:

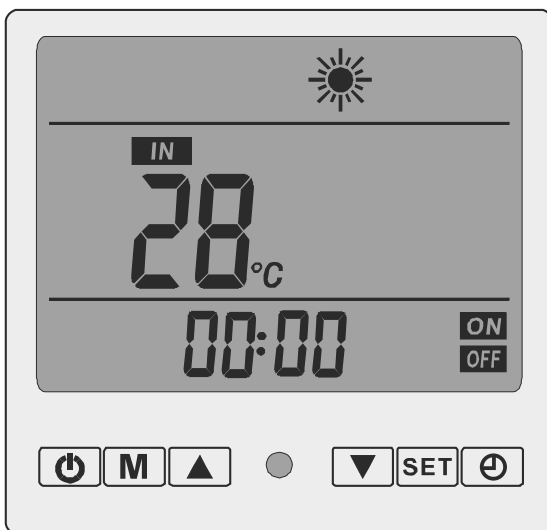

Fig.5

Under standby mode or operation mode, press **⏻** once, screen show as Fig.5; then

00:00 and **ON** both blink, press **⏻** again, **00:** blink, then press **▲** or **▼** to set hour of timing start; press **⏻** again, **:00** blink, press **▲** or **▼** to set minute of timing start.

Press **⏻** again, **00:00** and **OFF** both blink; press **▲** or **▼** to set hour of timing off;

press **⏻** again, **:00** blink, press **▲** or **▼** to set minute of timing off. After setting,

press **⏻** once to confirm, screen shows your settings. And the unit will start and shut down (off) according to your settings. To cancel the timing ,press **⏻** once and then press **SET** !

6.Parameter setting:

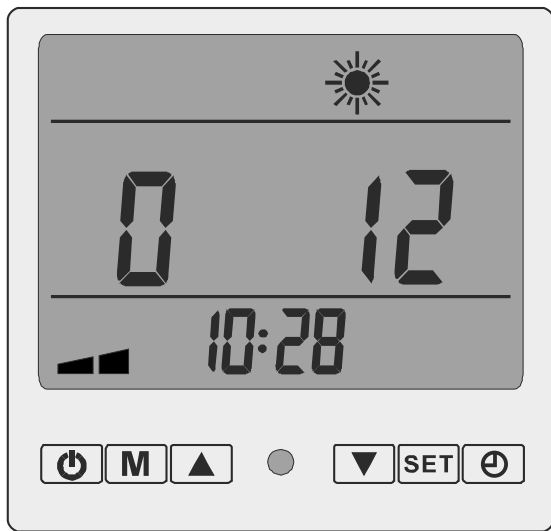

Fig.6

Under standby mode, press or once, screen shows 0 12 (0 means screen display number(sn), 12 means the data of parameter). Press , 12 blink, press or to set the data. Press once to confirm. Then press or to select another parameter. Under operation mode, press or once, screen shows 0 12 ,etc, but data can not be adjusted. Please refer to below:

Parameters	Definition	Range	Default	Remark
0	Invalid	8℃ ~28℃	12℃	Adjustable
1	Hot water setting temperature	25℃ ~80℃	55℃	Adjustable
2	Defrost cycle	30~90Min	40Min	Adjustable
3	Defrost starting temperature	-30℃ ~0℃	-7℃	Adjustable
4	Defrost exiting temperature	2℃ ~30℃	13℃	Adjustable
5	Defrost time	1-12Min	8Min	Adjustable
6	Manually or automatically control on Electronic expansion valve	0(manual)/ 1(Auto)	1(Auto)	Adjustable
7	Display water outlet temp or not	0:no display 1:yes	1	Adjustable
8	Return water differential setting	2℃ ~15℃	5℃	Adjustable
9	Water pump mode	0(regular)/ 1(special)	0	Adjustable
A	Over heating temperature setting	-F(-15℃)~F(15℃)	5℃	Adjustable
B	Expansion valve manual steps	0(0 step)~ 50(500 steps)	35(350 steps)	Adjustable
C	Second set point Maximum temp Range	25℃ ~80℃	80℃	Adjustable
D	Second set point Minimum temp range	40℃ ~55℃	50℃	Adjustable
10	Water inlet temp	0℃ ~127℃		Actual testing data
11	Water outlet temp	0℃ ~127℃		Actual testing data
12	Coil temperature	-9℃ ~99℃		Actual testing data
13	Air Circulation temperature	-9℃ ~99℃		Actual testing data
14	Ambient temperature	-9℃ ~99℃		Actual testing data
15	Compressor exhaust temperature	0~C7℃(127℃) (A:100℃,B:110℃,B:120℃)		Actual testing data
16	Expansion valve actual step number × 10	12-47		Actual testing data

Note: setting shall be operated by professional technician to avoid wrong operation. currently heat pump use capillary instead expansion valve.all description about expansion valve is not valid!

7. Malfunction Display / System Protection

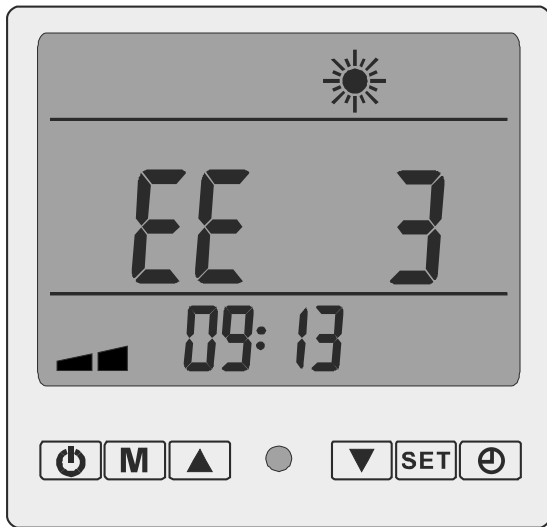

If screen show EE 3 as Fig.7, means malfunction for water flow switch, Malfunction code see below:

Fig.7

Protection/Malfunction	LCD display	Indicating Light
Standby		Off
Normal start		Blink
Water inlet temp sensor failure	PP 1	☆ ● (1 blink 1 off)
Water outlet temp sensor failure	PP 2	☆☆ ● (2 blink 1 off) Invalid when Parameter 7 choose 0
Coil temp sensor failure	PP 3	☆☆☆ ● (3 blink 1 off)
Air circulatio temp sensor failure	PP 4	☆☆☆☆ ● (4 blink 1 off)
Ambient temp sensor failure	PP 5	☆☆☆☆☆ ● (5 blink 1 off)
Winter 1 st antifreeze protect	PP 7	Off
Winter 2 nd antifreeze protect	PP 7	Off
Air exhaust temp sensor failure	PP 8	
Gas high pressure protect	EE 1	☆☆☆☆☆☆ ● (6 blink 1 off)
Gas low pressure protect	EE 2	☆☆☆☆☆☆☆ ● (7 blink 1 off)
Water flow switch failure	EE 3	☆☆☆☆☆☆☆☆ ● (8 blink 1 off)
Exhaust air temperature too high	EE 6	
Defrost	☀ Blinks	☆☆☆☆☆☆☆☆(long blinks)
Communication failure	EE 8	Only valid for wire controller

Note: some heat pump do not have the indicating light.

8 Setting about S1 & S2 switch

S1 Switch---Second Set Point

S2 Switch----Long distance demand

8.1 Second Set Point available when S1 switch has well connected.

At the same time, water temp set point setting decided by ambient temp, Parameter 9 and Parameter 10. (Both 9 & 10 Parameter would be adjusted)

Parameter 9 (maximum setting range 65~80 ° C)

Parameter 10 (minimum setting range 40~55 ° C)

A. When ambient temp < 5° C, set point temp refer to the data of Parameter 9

B. When ambient temp >15° C, set point temp refer to the data of Parameter 10

C. When 5° C ≤ ambient temp ≤ 15° C, Set point temp = Data of Parameter 9- (Data of parameter 9- data of parameter of 10)/(15-5)*(Ambient temp -5)

For example, when ambient temp is 18 deg c, Parameter 9 data is 60 deg c, Parameter 10 data is 20 deg c. Then set point temp =60-(60-20)/(15-5)*(18-5)

8.2 When S1 disconnected, set point temp control by LCD controller. (Refer to the setting of Parameter 40 (default setting 50 deg c).

8.3 Heat pump will turn on when S2 switch has well connected. However , S2 well connected, and suddenly press the off button on the LCD controller. Heat pump will stop for 3 minutes. After 3 minutes heat pump continue to turn on if S2 Still has been connected.

8.4 The timer function is out of validity when S2 switch is connected.

8.5 Heat pump turns of f when S2 switch is disconnected. Meanwhile, need to use LCD controller to switch on/off the heat pump.

Wire Circuit Diagram

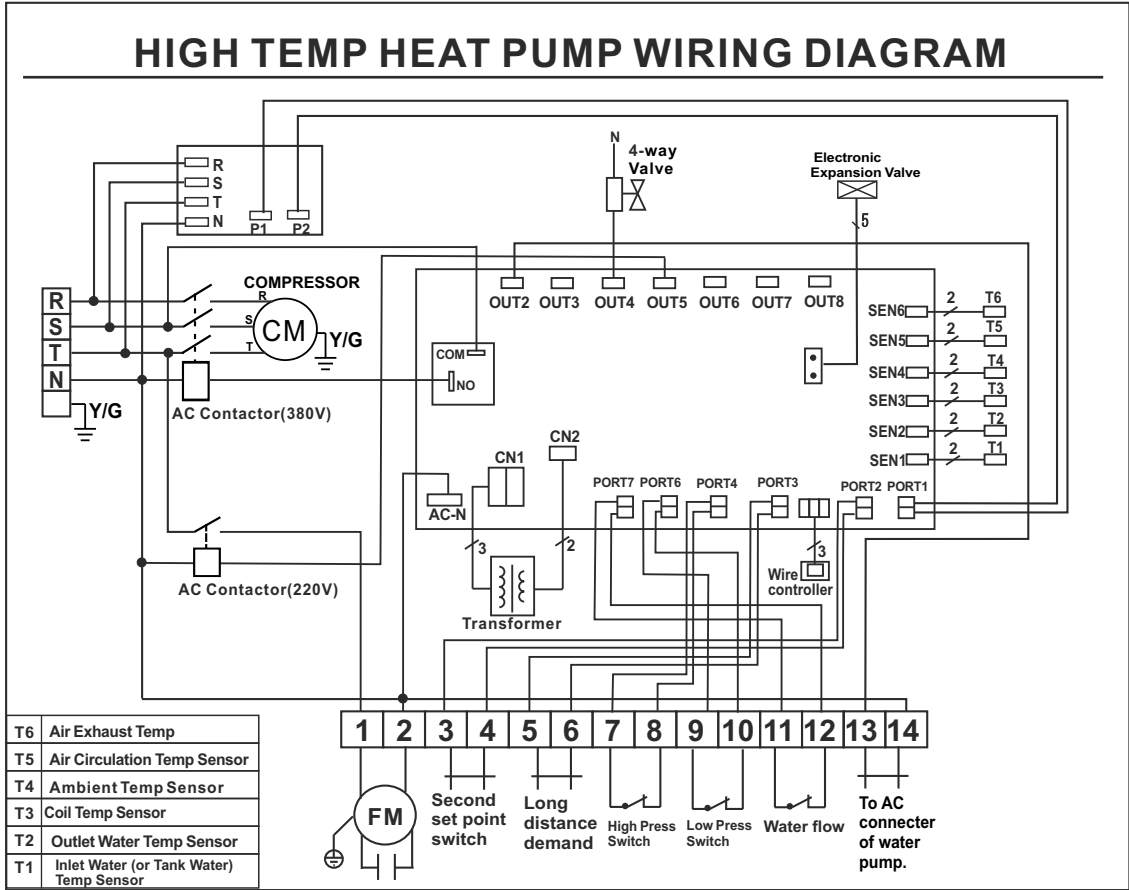

Installation instructions

1. Unit installation

1). Installation location

Host unit

- ²Should be installed in a larger & well-ventilated place.
- ²Installation location should ensure unhindered access outlet (inlet & outlet shown as below).
- ²Install gutter or set up positions near the outfall, to facilitate the drainage.
- ²The installation base or bracket should be steady, to ensure the smooth operation of running units.
- ²Make sure the unit is vertical after installation, and no incline.
- ²Make sure not to install the host unit in the any conditioner of pollution, corrosive gases, sun and fallen leaves, etc.
- ²Installation location must not next to place of incendive , easy-explosion and fire .
- ²Installation must pay attention to the distance between the barriers shown in below picture (pay attention to arrow direction).

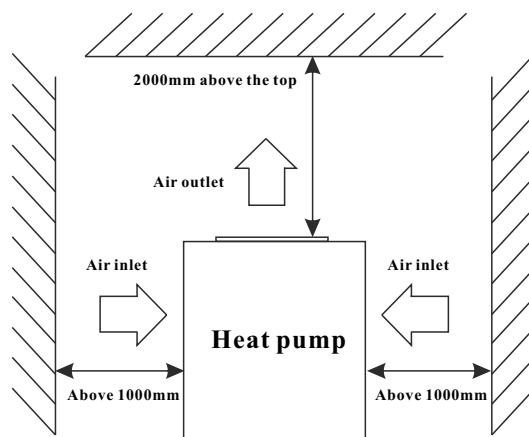

Water tank

- ²Water tanks should be placed where ambient temperature is above 0°C .
- ²Can be installed outdoors or the top of the building (based on the size of water tanks and the load-bearing capacity of the building and so on).
- ²Do not install water tanks in the pollution, corrosive gases place.

2). Unit installation

- ²Units base can be installed as cement concrete structures, steel brackets can also be used, add the shockproof rubber pads , make the base surface flat.
- ²Units can be designed based on the working performance.
(See Table of technical performance parameters)
- ²Unit should have drain or drainage inlets.
- ²Normally required to install in the place where setted cement concrete base.

Installation instructions

2. Pipeline connecting

Installation notes:

- ²Water drain pipes, overflow pipes should be installed next to the drainage inlets to facilitate drainage, vent valve should be installed on vent pipes.
- ²Repair valve should be installed in front of the electromagnetic valve on the pipeline system, which is convenient for future repair.
- ²User water pressure should less than 0.6 Mpa.
- ²All pipelines should choose metal pipe (such as stainless steel, with Lining Plastic and lining stainless steel and thin-walled copper pipe or, etc.). The use of plastic pipe (such as the PP-R, ABS, etc.) should consider the pipeline expansion between the host unit and water tanks .
- ²Water supply and pause valves may need to keep warm in the winter (according to the local winter temperature) to avoid the broken of water supply and pause valve.

Water system installation

- ²All the pipeline tubing should be matched as shown on the manual, and in accordance with national corresponding construction standards.
- ²Installation of water pipes should be straight and flat, pipeline collocation should be rational, ensure to minimize bending; reduce the resistance loss of the water system.
- ²Pipeline and connecting parts are not allowed a leakage phenomenon.
- ²After the installation of circulating pipe between tap water pipes, host unit and water tanks ,should carry out water leakage testing, and eject the sewage to ensure the system's cleanness.
- ²If no water leakage, keep the hot water pipe warm.

3. Project example:

Application of heat pump water heater engineering systems have different forms. Here are two kinds of stand-alone group water heating system, only for your reference.

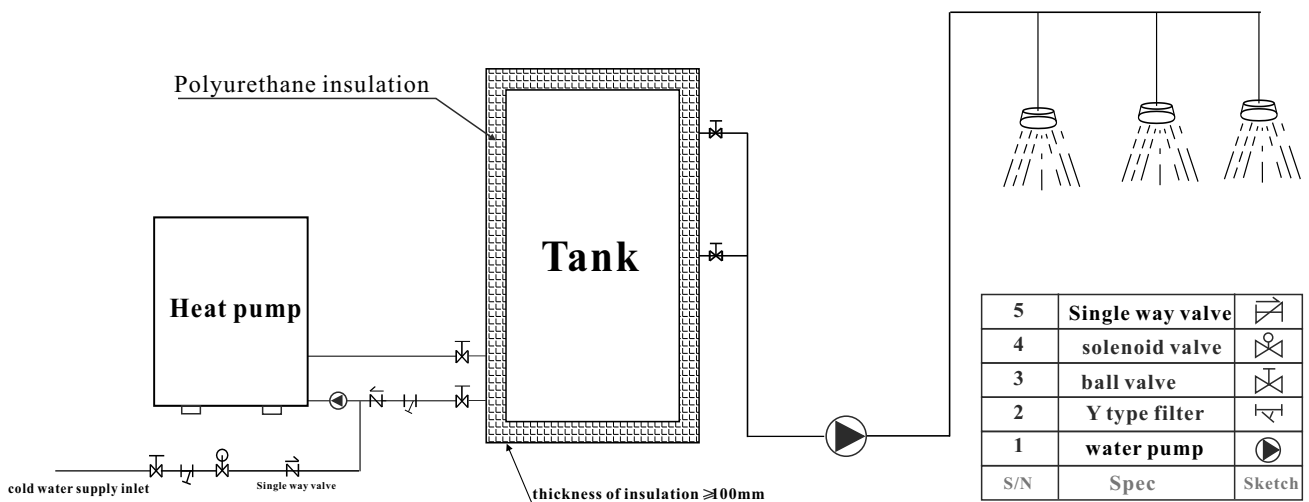

WARNING!

Due to the high temp heat pump could offer much hotter water (70-80 deg c) than the usual heat pump (60 deg c).

The water piping and insulation of water heat exchanger should be once or twice more thicker and more stronger. Better to be more than 50mm.

Highly suggest to use waterproof insulation piping when the unit install outdoor.

All water piping, valve, water flow switch , circulation pump use in high temp heat pump must be Allow to work between 0 to 100 deg c. Due to the high temp heat pump could offer max 70- 80 deg c hot water.

The tank connect to high temp heat pump should be difference from the one use in usual heat pump (60 deg c hot water outlet).

A air valve or a pressure relief valve should be add in the tank. And insulation of water tank must be thicker than 100mm.

Running Test and operation

1. Preparatory work before the running test.

a) Inspection of heat pump water heater units:

- Check if the unit appearance and the pipeline system were damaged during transport.
- Check if there is air exist in the water pipes, if yes, should empty all the air inside by the manual exhaust valve and the exhaust valve on the water pumps.
- Check if the fan rotor interference the fan fixing board and fan protection net.

b) Check the electricity distribution System

- Check if the power supply same as shown on manual and rating label.
- Check if all the power supply and control wiring are all well connected, check if the wiring is connected as wiring diagram and reliability of earth wiring.

c) Check Pipeline system

- Check the pipeline system, make sure the water supply pipes, water return pipes, pressure gauges, thermometers, valves, water flow switch are safe and correct.
- Check if having opened all the valves that should be opened, and having closed all valves that should be closed.
- Check if all necessary attemperators are good.

Running Test and operation

2. Running test

This running test must be performed by professional staff!

- ☐ Overall test can be run if the entire system inspection is conformed to regulations.
- ☐ Connected to power, start the heat pump, host unit delays three minutes then auto-start. For three-phase power supply unit, first check whether the fans and pumps' rotary direction correct or not, if not, immediately shut down the power and adjust phase sequence. Measure the compressor operation current, and if any abnormal noise. Check whether the unit conform to the requirements, run for a period of time (general 3 days), after that, the unit can be used normally.

3. Normal operation

- ☐ Heating process: start - up - water pumps runs - water flow switch inspection --- Fan operation compressor operation (when the low water level cut off, water supply induction valve opens)
- ☐ Operation Control:

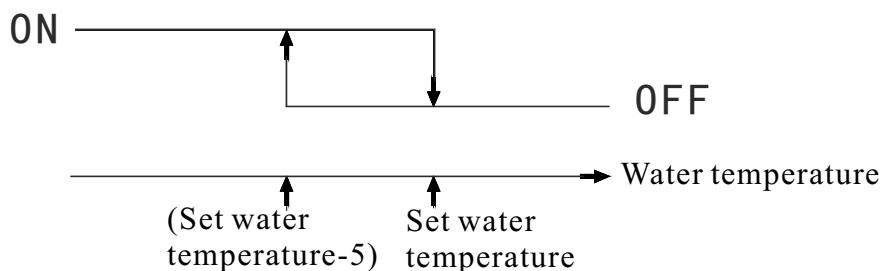

- ☐ Water level control: When the low level switch disconnect, open the water supply induction valve to supply enough water, meanwhile stop the water supply pump. Open the water supply pump when high level switch closed, After high-level switch closed for two minutes, open water supply induction valve (at least 2 minutes).
- ☐ When water pump is on and the high level switch cut off, if water temperature $<$ (set Temperature - 5 degrees), shut down water supply for tanks, If water tank temperature $>$ (temperature - 2 degrees) then open the water supply induction valve, after high-level switch closed for two minutes stop the water supply induction valve. When water pumps stopped, whatever conditions, should supply enough water. (Water supply switch on at 2 minutes).
- ☐ For the first power-on boot, the circulating water pump, compressor, fan motor runs after low level switch closed.
- ☐ During the unit operation, circulating pump open. When the unit stopped, the circulating pump will be delayed 30 seconds then stop functioning.
- ☐ When water pumps open, meanwhile open water return induction valve, 10 minutes later, test the return water temperature, when the return water temperature $>$ (water temperature - 5 degrees), the return water induction valve stops. If the return water temperature $<$ (tank water temperature - 10 degrees), open the water return valve so that the water supply pump constantly store the hot water. When water supply pump closed, shut down the water return valve at the same time.
- ☐ For normal start-up, the 4-way valve cut off, only when defrosting, the unit will work in normal.

Maintenance

Heat pump water heater is a high automatic equipment, please perform regular inspection termly. If the unit can be long-term and efficiently maintenance, the operating reliability and service life will have an unexpected increase.

- 1.The extra water filters should be cleaned regularly to ensure clean water quality of the system, and to avoid damage caused by dirty water filter blocking.
- 2.Users should pay attention for usage and maintenance to below : all units' protection devices are set up before leaving factory, do not make any adjustment by yourself.
- 3.Frequently check the power supply and electrical wiring system is solid or not, whether electrical components are abnormally working, if yes, should timely maintenance and change for a new one.
- 4.Perform regular checks of the water supply system, check whether the tank safety valve, liquid level controller and exhaust devices work properly, so as to avoid air into the system, and reduce the water cycle volume, thus affect the heating function and operation reliability.
- 5.Check whether pumps and water valves are normal working or not, whether water tubing and water pipes connector are leakage or not.
- 6.The unit and around should remain clean, well-ventilated. Regularly clean (1-2 month)the side air heat exchanger to maintain a good effect of heat exchange.
- 7.Frequently check whether each part of the unit work normal or not, check whether there is oil on the pipeline joints and charging valve to ensure that no refrigerant leakage.
- 8.Do not piling up debris around the unit, so as not to block from air inlet and outlet, the unit around should be kept clean the dry, well-ventilated.
- 9.If the unit stops for a longer time, should drain all the water in the pipeline, cut off power supply, and sets the protective equipment.When re-run the unit, complete inspection is a must before reboot.
- 10.When unit failure, and the user can not resolve the problem, please call our Company in local maintenance department, in order to promptly send people for maintenance.
- 11.Host condenser cleaning.We propose to use 50°C-60°C, and 15% hot phosphoric acid for condenser cleaning, launch the circulating pump of the host unit for three hours' cleaning, finally rinse with water three times. (Propose to back up a 3-way connector when installing the pipeline, block one joint),in order to clear the connection pipe. Do not use corrosive cleaning fluid for condenser cleaning.
- 12.Water tanks need to remove theWater scale after some time (normally two months, according to the water quality of local place).

High Temp Heat Pump-Water Heater
